

Product information sheet AXIA III 6 S

Item no. 523472

Benefits



- Flowing ergonomic work space along a single axis thanks to arrangement of bowls and multifunctional accessories
- Design that is notable for clear lines and the ultra-narrow, flat rim
- Tight radii for maximum utilisation of the surface and volume
- Movable glass cutting board for working directly into cooking dishes
- Multifunctional colander can also be freely positioned in the main bowl for easy food preparation
- High-quality features with the covered C-overflow and integrated InFino basket strainer
- Available in left or right handed versions

Colours



SILGRANIT anthracite

Available colours:

rock grey
alumetallic
anthracite
white
jasmine
pearl grey
coffee
tartufo
black

Planning information

- Cut out: 980 x 490 x R15Bowl depths: 190/130mmPlease specify hand of bowl

Scope of supply

- glass cutting board
- multifunctional stainless steel colander
- waste kit with space-saving pipe
- 2 x 3 ½" InFino basket strainer with remote control for the main bowl

Details

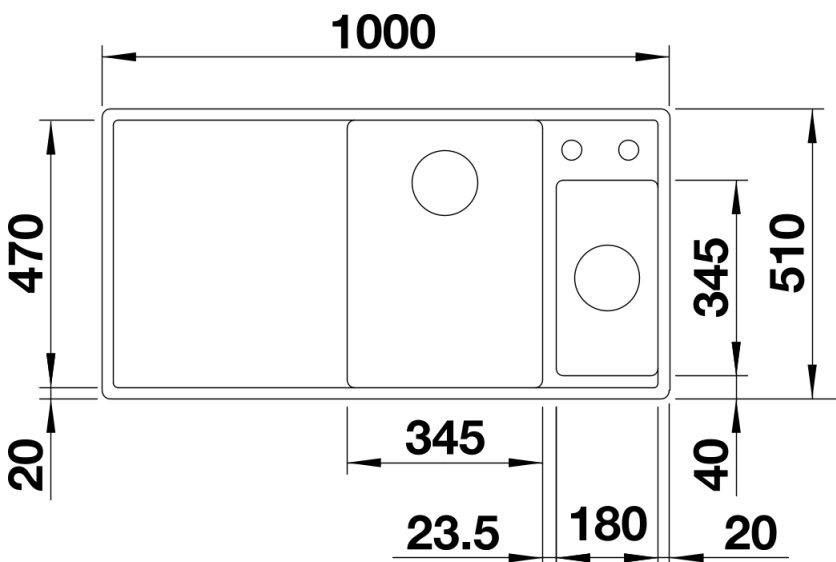

Top view

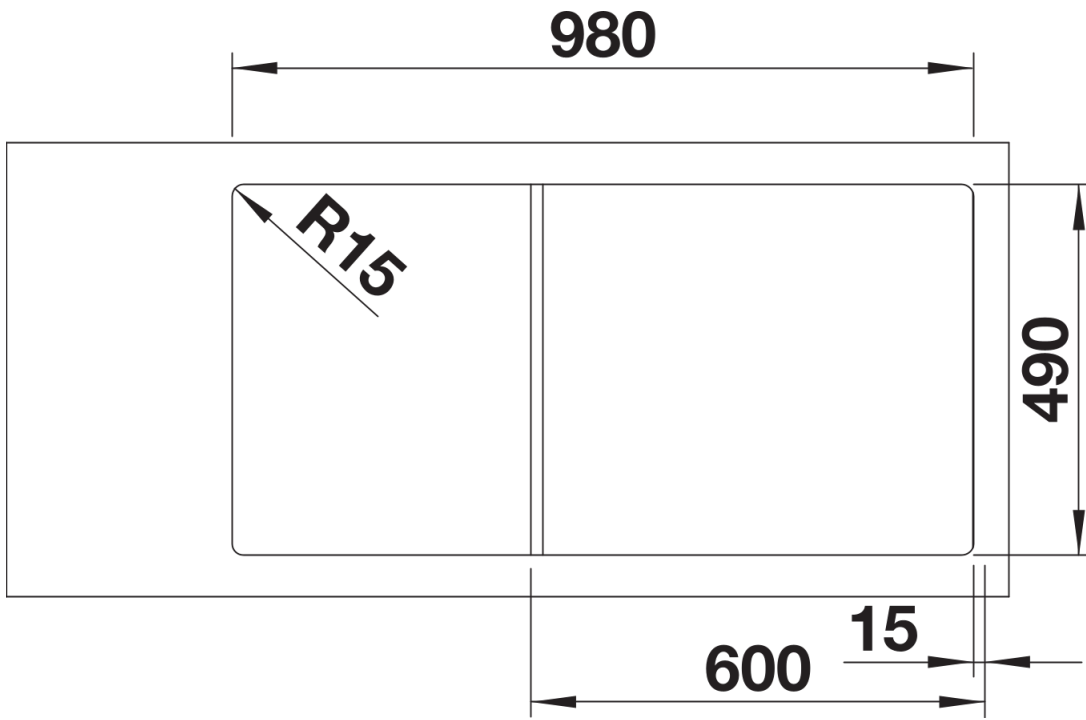

Cut-out

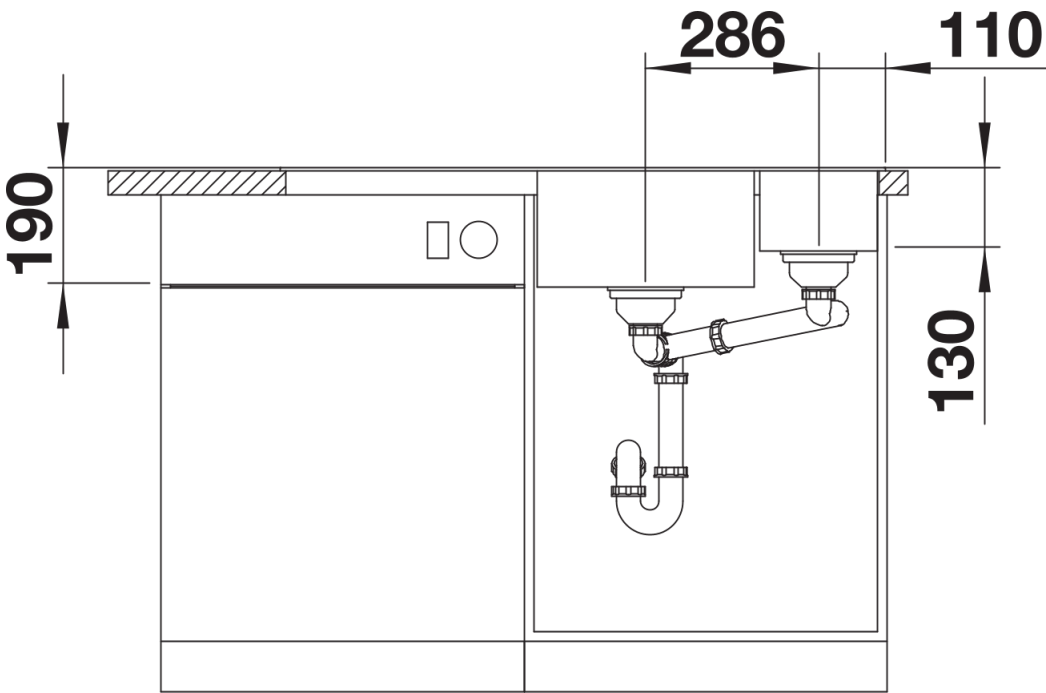

Front view

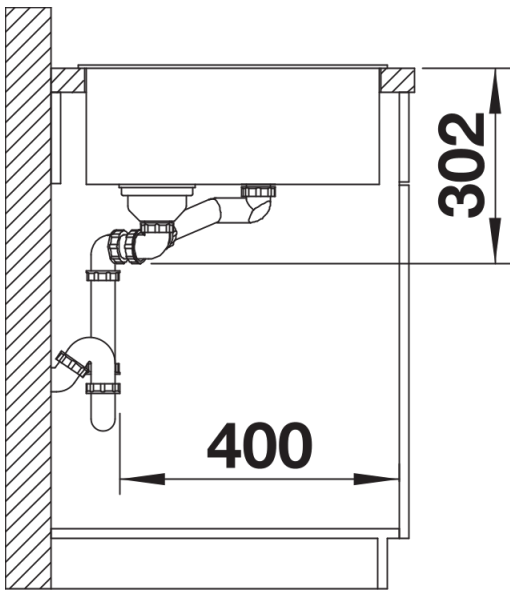

Side view